

Project Name:	Part Number:	Type:
---------------	--------------	-------



407-478-3759
www.ilp-inc.com

UTILITY WRAP

FEATURES

- 2ft and 4ft configurations
 - 2ft: Selectable 1800/2400/3000 Lumens
 - 4ft: Selectable 3600/4800/6000 Lumens
- Selectable CCT: 3500K/4000K/5000K
- Sleek modern design with frosted polycarbonate impact resistant lens
- White post-painted durable steel housing
- Surface, Suspended, Junction box and FMB mounting options
- Integrated microwave sensor option
- Sensor option to fully control occupied & unoccupied light levels
- Integrated emergency driver options
- 0-10V Dimmable Driver, dim-to-off
- 120-277V Universal Voltage
- Ambient Temperature Range -4°F-104°F (-20°C-40°C)
- Calculated L70 >75,000 Hours @ 25°C per TM-21-11
- 5 Year Warranty
- ETL Listed for Damp Location
- DesignLights Consortium® Qualified Luminaire



SUITABLE APPLICATIONS

- Hallway
- Workstation
- Storage Facility
- Warehouse
- Distribution Center
- Manufacturing Plant

ORDERING GUIDE:

SERIES	LUMENS (SELECT ONE)	DRIVER	CCT
SWR2 2ft Utility Wrap	18L/24L/30L	U	CCTS CCT Selectable 35K, 40K, 50K
	18L	120-277V	35
	24L		40
	30L		50
SWR4 4ft Utility Wrap	36L/48L/60L		
	36L		
	48L		
	60L		

OPTIONS	
Factory Installed	
EM5 ⁴	5W LED Factory Installed Battery Backup
EM10 ⁴	10W LED Factory Installed Battery Backup
MWS ^{2,5}	Factory-installed microwave sensor
FMB	Fixture Mounting Box
VC	V-Clips for chain hanging
Cx/3W/515P	Cord w/ 120v Straight Blade Plug (x=Length; 6,10,15)
Cx/yW	Cord; (x=Length;6,10,15) (y=# of conductors; 3,4,5,6)
Ship with Accessories	
+SWR-MW/RC ³	Microwave sensor remote
HUB 3/4 ¹	¾" Conduit Hub for Pendant Mounts
+SWR-ACxL	Loop Aircraft Cable System (x=' Length; 5, 10, 15, 20)
+SWR-ALBR ⁶	Alignment Bracket (used to align fixtures mounted in continuous rows)

¹ Requires an FMB
² Integral to fixture, behind lens
³ One needed per project when using MWS
⁴ If used with MWS, only compatible with SWR4
⁵ If used with EM, only compatible with SWR4
⁶ SWR not compatible with continuous wiring through fixtures



QUICK SHIP ITEMS:

SERIES	LUMENS	DRIVER	CCT
SWR2	18L/24L/30L	U 120-277V	CCTS CCT Selectable 35K, 40K, 50K
SWR4	36L/48L/60L		

SWR

UTILITY WRAP

LED SYSTEMS INFO ¹	3500K		4000K		5000K		Wattage ²	DLC
	Part Numbers	Lumens	Efficacy	Lumens	Efficacy	Lumens		
SWR2-18L/24L/30L	2765 lm	113 lm/W	2835 lm	118 lm/W	2832 lm	115 lm/W	24 W	Standard
SWR2-18L	1648 lm	112 lm/W	1684 lm	116 lm/W	1706 lm	115 lm/W	15 W	Standard
SWR2-24L	2225 lm	114 lm/W	2283 lm	118 lm/W	2292 lm	116 lm/W	20 W	Standard
SWR2-30L	2765 lm	113 lm/W	2835 lm	118 lm/W	2832 lm	115 lm/W	24 W	Standard
SWR4-36L/48L/60L	5799 lm	113 lm/W	5947 lm	120 lm/W	5907 lm	114 lm/W	51 W	Standard
SWR4-36L	3597 lm	117 lm/W	3657 lm	122 lm/W	3691 lm	119 lm/W	31 W	Standard
SWR4-48L	4707 lm	115 lm/W	4810 lm	121 lm/W	4812 lm	117 lm/W	41 W	Standard
SWR4-60L	5799 lm	113 lm/W	5947 lm	120 lm/W	5907 lm	114 lm/W	51 W	Standard

¹Values are nominal, see IES file for more detail
²Electrical data at 25C (77F). Actual wattage may differ by +/-10%.

ELECTRICAL DATA (AMPS)

Lumen Package	Wattage	120V	208V	240V	277V
SWR2-18L/24L/30L-U-CCTS	24.6 W	0.2 A	0.1 A	0.1 A	0.1 A
SWR4-36L/48L/60L-U-CCTS	51.0 W	0.4 A	0.2 A	0.2 A	0.2 A

¹Electrical data at 25C (77F). Actual wattage may differ by +/-10%

LINE DRAWINGS

SWR2 - 2FT

* All dimensions shown in inches

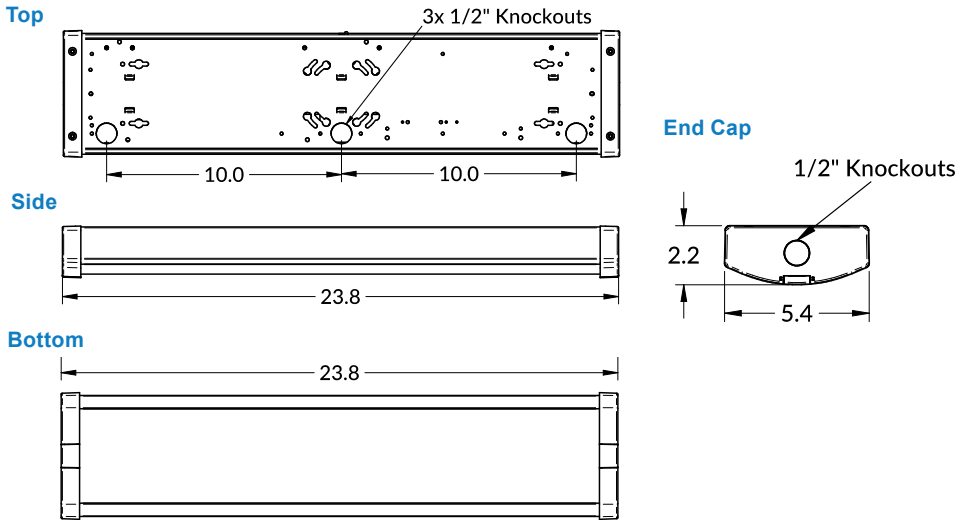

SWR4 - 4FT

* All dimensions shown in inches

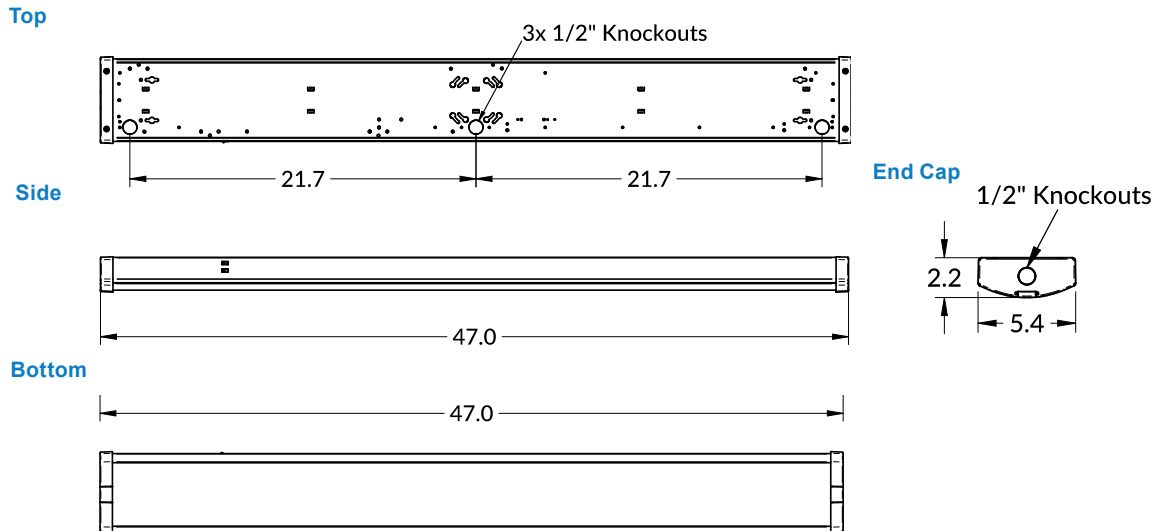

SWR

UTILITY WRAP

SWR4 - FMB - 4FT

Top

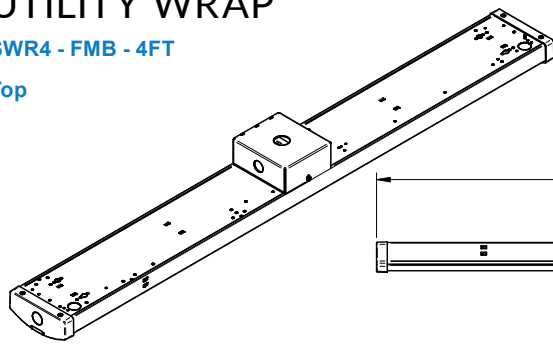

Side

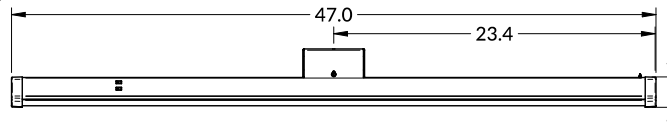

End Cap

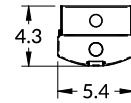

SWR4 - ALBR - 4FT

Top

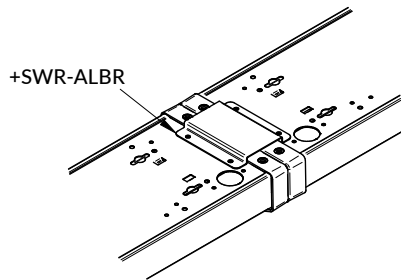

Side

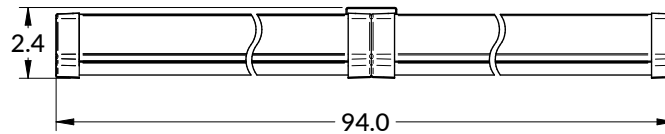

End Cap

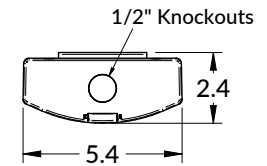

SWR4 - AC - 4FT

Side



End Cap



SPECIFICATIONS

CONSTRUCTION

Steel housing with white gloss finish for rigidity, durability and ease of installation. Injection molded end caps provide sleek and robust design. Designed to achieve maximum performance and aesthetics.

ELECTRICAL

Class 2 LED light engine for high efficacy and long life. Calculated L70 > 75,000hrs. Power Factor > 0.90. Standard 120-277 Vac 0-10V dimmable with low end cutoff for dim-to-off functionality.

INSTALLATION

Designed for a variety of mounting solutions including surface, Junction Box, pendant/FMB and cable-suspension. Common 1/2" knockouts are available on top of fixture for electrical access and/or mounting.

OPTICS

High transmission frosted polycarbonate lens for durability and LED glare reduction. Integrated access latches for toolless field removal of lens for easy installation and maintenance.

WARRANTY

5 Year Warranty Standard ([Terms and Conditions apply](#)).

CONTROLS

Optional factory-installed microwave sensor hidden within the fixture provides optimal occupancy and photocell control.

CERTIFICATIONS

ETL Listed to US and Canadian safety standards. Suitable for damp locations.

SWR

UTILITY WRAP CONTROL OPTION

BASIC

MWS

Optional factory-installed microwave sensor hidden within the fixture provides optimal occupancy and photocell control.



Pre-set Program

Detection Area:	100%
Hold Time:	5 Seconds
Stand-by Period:	0 Seconds
Stand-by Dim Level:	10%
Daylight Sensor:	Disabled

Button Remarks

Daylight Sensor
Set daylight threshold
5Lux/15Lux/30Lux/50Lux/100Lux/150Lux/Disable

Stand-by Period
Length of time fixture is held at dimmed level before turning off. If set to 'infinite', fixture will operate in high-low operation and not turn off.
0s/30s/1min/3min/5min/ 10min/20min/30min/∞

Hold Time
Length of time fixture will stay at maximum light level from when motion is detected. 5s/30s/1min/3min/5min/10min/20min/30min

Stand-by Dim Level
Not Applicable

Detection Area
Set detection area
25%/50%/75%/100%

Remote Distance
Set distance between remote and sensor.
5m, 10m, 15m

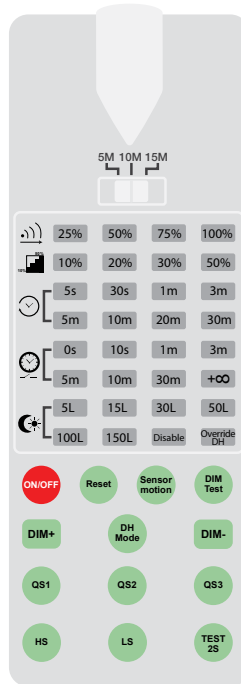

MW/R/C

Sensor Remote Control. One needed per project when selecting Sensor (MWS) option.

Button Remarks

	Turns fixture 'ON/OFF'
	Brings the sensor back to pre-programmed factory settings
	Press "Sensor Motion" button, the light quits from the constant on/off mode, and the sensor starts to work (The latest setting stays in validity)
	Not Applicable
	Not Applicable
	Not Applicable
	Not Applicable
	Pre-set 'Quick Selections'

Scene Options	Detection Area	Hold Time	Stand-by Period	Stand-by Dim Level	Daylight Sensor	Sensitivity
QS1	100%	5 Min	10 Min	10%	30 Lux	HS
QS2	100%	10 Min	30 Min	10%	Disable	HS
QS3	100%	20 Min	30 Min	10%	Disable	HS

Places fixture to test mode. This function is for testing only. Press 'RESET' to revert to pre-set program.

TEST 2S
Settings:
- Detection Area: 100%
- Hold Time: 5 seconds
- Stand-by Dim Level: 10%
- Daylight Sensor: Disabled

Adjustment based on 'Detection Area' parameter selected by field user.
HS = High Sensitivity to motion
LS = Low Sensitivity to motion

SENSOR COVERAGE PATTERNS

CEILING MOUNT

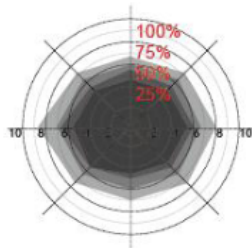

Speed: 1m/s

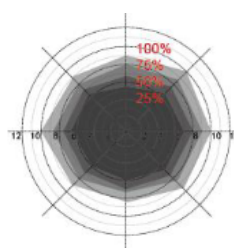

Speed: 0.3m/s

Ceiling mounted

height: 3m

Sensitivity:

100%/75%/50%/25%

WALL MOUNT

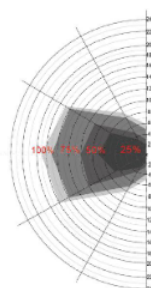

Speed: 1m/s

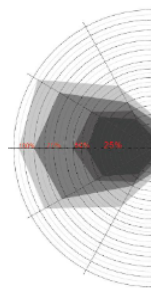

Speed: 0.3m/s

Horizon mounted height: 2m

Sensitivity: 100%/75%/50%/25%

SWR

UTILITY WRAP

MOUNTING OPTIONS

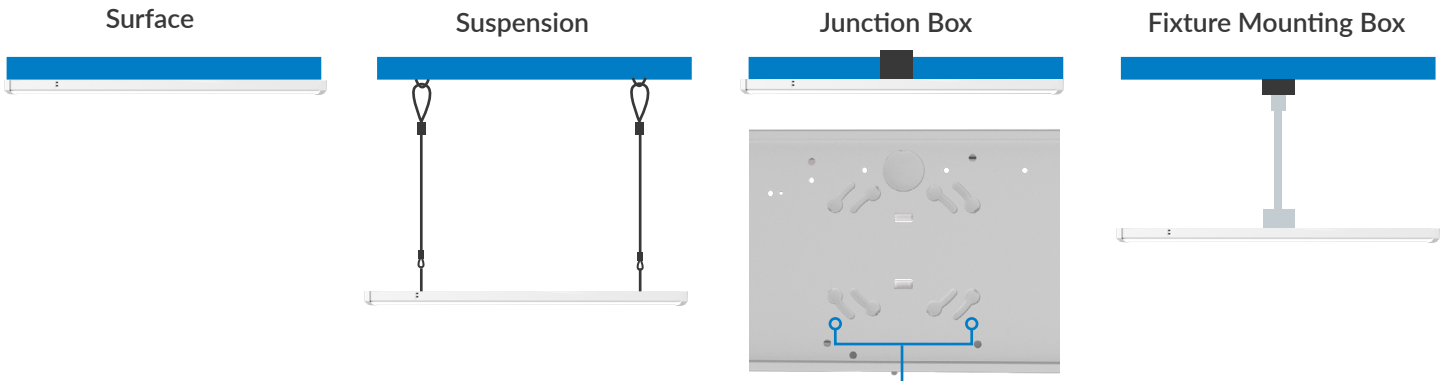

HUB 3/4

Conduit Hub 3/4" for Pendant Mounting



ACxL

Includes 2 adjustable cable hangers.
Available in 5', 10', 15', 20'

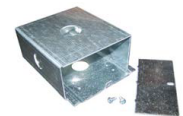

FMB

Includes rigid box to attach to the fixture, provides for single point mounting to accept a pendant or conduit hub (sold separately)

PHOTOMETRIC REPORTS

LUMINAIRE DATA	
Part Number	SWR2-30L-U-40
Description	2ft Utility Wrap, 3,000 Lumens, 4000K
Fixture Lumens (lm)	2835 Lumens
Wattage (W)	24 W
Efficacy (lm/W)	118 lm/W
Mounting	Pendant
Spacing Criteria	0° = 1.22, 90° = 1.24

ZONAL LUMEN SUMMARY		
Zone	Lumens (lm)	% Fixture
0° - 40°	1274	45%
0° - 60°	2211	78%
0° - 90°	2804	99%
90° - 180°	31	1%
0° - 180°	2835	100%

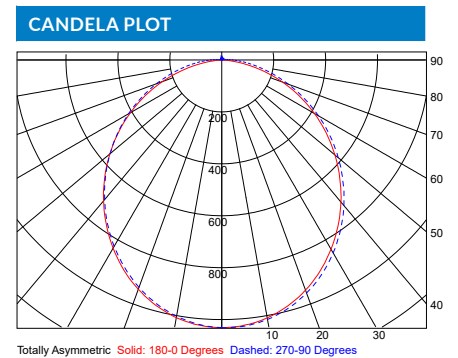

LUMINAIRE DATA	
Part Number	SWR4-60L-U-40
Description	4ft Utility Wrap, 6,000 Lumens, 4000K
Fixture Lumens (lm)	5947 Lumens
Wattage (W)	49.5 W
Efficacy (lm/W)	120 lm/W
Mounting	Pendant
Spacing Criteria	0° = 1.24, 90° = 1.24

ZONAL LUMEN SUMMARY		
Zone	Lumens (lm)	% Fixture
0° - 40°	2628	44%
0° - 60°	4590	77%
0° - 90°	5876	99%
90° - 180°	71	1%
0° - 180°	5947	100%

