



# WTZ

## NARROW LINEAR VAPOR TIGHT

PRODUCT  
OVERVIEW



SCAN OR  
CLICK HERE

### FEATURES

- Operates reliably in extreme conditions with an ambient temperature range from -40°F to 131°F and a robust fiberglass body.
- Maximizes energy efficiency with efficacy up to 156 lm/W and lumen packages ranging from 2,000 to 24,000.
- Adapts to diverse applications with multiple mounting options, including surface, pendant, wall, and suspended configurations.
- Enhances durability with IP65, IP66, IP67, NEMA 4X, IK10, and NSF certifications, along with a 1500 PSI hosedown rating.
- Offers customizable lighting with multiple lens options for glare reduction and CCTs from 2700K to 5000K in 80 or 90 CRI.
- Supports advanced lighting controls with wireless grouping capabilities and occupancy sensors for optimized energy use.

### DIGITAL NAVIGATION

Explore the spec sheet through the links below

[ORDERING GUIDE](#)   [AMBIENT TEMP. RANGE](#)   [LED SYSTEMS TABLE](#)   [QUICK SHIP](#)  
[CONTROLS](#)   [LINE DRAWINGS](#)   [PHOTOMETRIC DATA](#)



### SUITABLE APPLICATIONS

- Coolers & Freezers
- Greenhouse
- Healthcare
- Industrial
- Natorium<sup>18</sup>
- Food & Beverage Prep
- Pharmaceutical
- Education
- Parking Garage

### CERTIFICATIONS



### SPECIFICATIONS

#### CONSTRUCTION

Injection molded one piece 5VA rated fiberglass body with chemical resistant finish for rigidity, durability and prolonged life in rough environments. F1 weatherability rated housing. Toolless removable gear tray for quick and easy access to electrical. Captive latches fastened to housing to safely secure lens to housing. Designed to achieve maximum performance and improved aesthetics.

#### ELECTRICAL

Class 2 LED light engine for high efficacy and long life. Calculated L70 > 100,000hrs. LED Lumen Maintenance Estimates based on TM-21 projections for the light source at 25C ambient. Power Factor > 0.90. Standard 120-277V ac 0-10V dimmable (10% - 100%) with optional 347V - 480V ac step down transformer. Optional emergency battery backups and generator transfer device available to meet critical life safety lighting requirements. Fixture max ambient reduced for emergency battery backup and step down options.

#### INSTALLATION

Designed for a variety of mounting applications including surface, pendant, 45 degree wall mount and suspended. Pre-drilled holes on each side of fixture for electrical access and wiring. Hole plugged from factory with rubber IP rated seal. 1/2" hubs available for threaded power entry from both ends. Toolless hinged removable gear tray for quick and easy access to electrical.

#### OPTICS

Robust injection molded and impact resistant PMMA lens options for durability and LED glare reduction. Standard Ribbed Acrylic Frosted (RAFL), with optional Smooth Acrylic Frosted (SAFL), Smooth Acrylic Clear (SACL), Smooth Polycarbonate Frosted (SPFL) and Smooth Polycarbonate Clear (SPCL) lens options. Field removeable lens for easy access to LED boards, drivers and maintenance. IK10 rated with SAFL, SACL, SPFL, & SPCL Lenses. IK07 with RAFL lens. 80 CRI Standard (3000K-5000K) with optional 90 CRI (2700K-5000K).

#### THERMAL

Ambient temperature range -40°F up to 131°F (-40°C to 55°C) on select models with cold start ambient temperature options. Fixture to be mounted at a minimum plenum height of 18" for suspended mounting. Reduced maximum ambient for surface mounting. Reference Ambient Temperature Ratings by lumen package in the Ambient Temperature Range table for more detail.

#### CONTROLS

Factory installed Advanced & Basic integral occupancy sensor options available. Fully control light levels for both occupied and unoccupied areas with user selectable bi-level dimming options to meet critical life safety lighting requirements. Advanced controls available for grouping capabilities and BAS operation. See controls pg for more detail (pg. 5).

#### CERTIFICATIONS

ETL Listed to US and Canadian safety standards. Suitable for Wet Locations. American Recovery and Reinvestment Act Funding Compliant. BAA Compliant. IP65, IP66, IP67 Rated. NSF Listed. 1500 PSI Hosedown Rated. NEMA 4X Rated DLC (DesignLights Consortium) Premium Qualified. Please refer to the DLC Qualified Products List at [www.Designlights.org/QPL](http://www.Designlights.org/QPL) to confirm specific product qualifications.

#### WARRANTY

5 Year Warranty Standard; 10 Year Warranty Optional ([Terms and Conditions apply](#)).



# WTZ

## NARROW LINEAR VAPOR TIGHT

### ORDERING GUIDE

PART #

Example: WTZ4-8L-U-30-RAFL-SS-DIM1-EM10-NURO-SP1-FMB/HUB12

SERIES	LUMENS	INPUT VOLTAGE	CRI/CCT	LENS	LATCHES
WTZ2 2ft Amazon	2L 3L 4L 6L	U 120-277V	80CRI/CCT 50 40 35 30	RAFL Ribbed Acrylic Frosted (Standard) SAFL Smooth Acrylic Frosted SACL Smooth Acrylic Clear SPFL Smooth Polycarbonate Frosted SPCL Smooth Polycarbonate Clear	BLANK None SS Stainless Steel Latches
WTZ4 4ft Amazon	3L 7L 4L 8L 5L 9L 6L 10L 12L		90CRI/CCT <sup>17</sup> 927 930 935 940 950		
WTZ8 8ft Amazon	6L 14L 8L 16L 10L 18L 12L 24L				

POWER ENTRY	SECURITY	ALTERNATE DRIVER	AMBIENT TEMP
BLANK None EMH1 <sup>10</sup> 1/2" HUB installed in one end of housing for power entry EMH2 <sup>11</sup> 1/2" HUB installed in both ends of housing for power entry	BLANK None TPS Tamper Proof Screws	BLANK None DIM1 1% Dimming Driver	BLANK None CT <sup>18</sup> -40°F Cold Start

EMERGENCY	CONTROLS OPTIONS	
	BASIC	ADVANCED
BLANK None EM5 <sup>6</sup> 5W LED Battery Backup EM5/HE <sup>6,14</sup> 5W LED Battery Backup - CEC Title 20 Compliant EM7 <sup>6</sup> 7W Battery Backup EM7/HE <sup>6,14</sup> 7W Battery Backup - CEC Title 20 Compliant EM10 <sup>6</sup> 10W Battery Backup - CEC Title 20 Compliant EM10/HE <sup>6</sup> 10W Battery Backup - CEC Title 20 Compliant EM10/HE/SD <sup>6</sup> 10W Self-Diagnostic Battery Backup - CEC Title 20 Compliant EM12 <sup>6</sup> 12W Battery Backup EMCT14 <sup>7</sup> 14W LED Cold Temp Battery Backup; -4°F (-20°C) - CEC Title 20 Compliant GTD <sup>7</sup> Generator Transfer Device	BLANK None WLOS <sup>3,5</sup> Wet-Location Rated On/Off End Mounted Occupancy Sensor WLOSPC <sup>3,5</sup> Wet-Location Rated On/Off End Mounted Occ Sensor w/ Photocell USBD <sup>3,5</sup> User Selectable Bi-Leveling Dimming End Mounted Sensor BDxx <sup>3,5</sup> Preset Bi-Level Dimming End Mounted Sensor BDxxPC <sup>3,5</sup> Preset Bi-Level Dimming End Mounted Sensor w/ Photocell MWS <sup>2,3,4,7</sup> On/Off Microwave Sensor Installed Behind Lens MWUSBD <sup>2,3,4,7,9</sup> User Selectable Bi-Level Dimming Microwave Sensor Installed Behind Lens	BLANK None ESMC/HB <sup>2,5,8</sup> EasySense High-Bay Sensor FSP311B/Lx <sup>3,5</sup> Drop Nipple Bluetooth PIR Sensor Lx = Mounting Height, - L2 = 10'MH - L3 = 20'MH NURO <sup>2,5,8,19</sup> NUROAir PIR Sensor NURO/MWS <sup>2,3,4,8,19,20</sup> NUROAir Microwave Sensor

STEP DOWN	PROTECTION	MOUNTING	WIRING	WARRANTY
BLANK None SD347 <sup>13,15</sup> 347V Step Down Transformer SD480 <sup>13,15</sup> 480V Step Down Transformer	BLANK None SP1 10kA Surge Protector Installed	BLANK None FMB/HUB12 <sup>13,12</sup> Fixture Mounting Box for Pendant Mounting with Conduit Hub 1/2" for Top Power Entry FMB/HUB34 <sup>13,12</sup> Fixture Mounting Box for Pendant Mounting with Conduit Hub 3/4" for Pendant Mounting	BLANK None C6/3W 3-wire cord standard fixtures 6FT C10/3W 3-wire cord standard fixtures 10FT C6/4W 4-wire cord for EM fixtures 6FT C10/4W 4-wire cord for EM fixtures 10FT C6/5W 5-wire cord for EM fixtures 6FT C10/5W 5-wire cord for EM fixtures 10FT 3WMR <sup>5</sup> 3-wire mini receptacle installed 3WMR/6 <sup>5</sup> 3-wire mini receptacle installed with 6ft cord	BLANK 5 Year 10YR 10 Year

CONTINUE TO NEXT PAGE



# WTZ

## NARROW LINEAR VAPOR TIGHT

### ORDERING GUIDE (Continued)

SHIP WITH ACCESSORIES	
+WTZ-AC6L-KIT	Adjustable 6' Loop Aircraft Cable Set Kit
+WTZ-AC10L-KIT	Adjustable 10' Loop Aircraft Cable Set Kit
+WTZ-AC6L/SS-KIT	Adjustable 6' Loop Aircraft Cable Set Stainless Steel Kit
+WTZ-AC10L/SS-KIT	Adjustable 10' Loop Aircraft Cable Set Stainless Steel Kit
AB45DEG/SS	45 Degree Stainless Steel Angled Mounting Bracket Set
MW/RC	Programming Tool for MWUSBD Sensor
ES/WWS/DR	EasySense Dual Rocker Wireless Wall Switch

### FOOTNOTES

- <sup>1</sup>Reference Ambient Temp. Range Table for more detail (below)
- <sup>2</sup>IP65 Rated
- <sup>3</sup>IP66 Rated
- <sup>4</sup>IP67 Rated
- <sup>5</sup>Does not qualify for NSF
- <sup>6</sup>Operating temp down to 32°F
- <sup>7</sup>Operating temp down to -4°F
- <sup>8</sup>Requires Bluetooth Enabled device for programming (provided by others)
- <sup>9</sup>Must be used with MW/RC option for commissioning
- <sup>10</sup>Cannot be used with combination of End Mounted sensor & power cord
- <sup>11</sup>Cannot be used w/ End Mounted sensor or power cord
- <sup>12</sup>One provided per 4ft section
- <sup>13</sup>Reference DLC website for current listing
- <sup>14</sup>Not available on WTZ2
- <sup>15</sup>Not compatible with EM options
- <sup>16</sup>When used with PC Lens and SS
- <sup>17</sup>Only available in:  
2': 2L-4L, 4': 3L-8L, 8': 6L-16L
- <sup>18</sup>Not available with Emergency options
- <sup>19</sup>Not available with GTD
- <sup>20</sup>Contact factory for specification compatibility



### QUICK SHIP ITEMS:

SERIES	LUMENS/WATTAGE	DRIVER	COLOR	PRIMARY LENS
WTZ4 4ft Amazon	4L	U 120-277V	50	RAFL Ribbed Acrylic Frosted
	7L		40	
WTZ8 8ft Amazon	12L	U 120-277V	50 40	RAFL Ribbed Acrylic Frosted

### AMBIENT TEMPERATURE RANGE

Part Numbers	Suspended (18 in.)	Surface Mount
	Standard <sup>1</sup>	Standard <sup>1</sup>
WTZ2-2L-U-XX-RAFL	-4°F to 127°F	-4°F to 126°F
WTZ2-3L-U-XX-RAFL	-4°F to 122°F	-4°F to 112°F
WTZ2-4L-U-XX-RAFL	-4°F to 115°F	-4°F to 103°F
WTZ2-6L-U-XX-RAFL	-4°F to 110°F	-4°F to 96°F
WTZ4-3L-U-XX-RAFL	-4°F to 132°F	-4°F to 130°F
WTZ4-4L-U-XX-RAFL	-4°F to 129°F	-4°F to 122°F
WTZ4-5L-U-XX-RAFL	-4°F to 127°F	-4°F to 115°F
WTZ4-6L-U-XX-RAFL	-4°F to 126°F	-4°F to 113°F
WTZ4-7L-U-XX-RAFL	-4°F to 125°F	-4°F to 111°F
WTZ4-8L-U-XX-RAFL	-40°F to 124°F	-40°F to 108°F
WTZ4-9L-U-XX-RAFL	-4°F to 122°F	-4°F to 104°F
WTZ4-10L-U-XX-RAFL	-40°F to 130°F	-40°F to 119°F
WTZ4-12L-U-XX-RAFL	-40°F to 129°F	-40°F to 118°F
WTZ8-6L-U-XX-RAFL	-4°F to 122°F	-4°F to 117°F
WTZ8-8L-U-XX-RAFL	-40°F to 129°F	-40°F to 115°F
WTZ8-10L-U-XX-RAFL	-4°F to 127°F	-4°F to 115°F
WTZ8-12L-U-XX-RAFL	-40°F to 124°F	-40°F to 120°F
WTZ8-14L-U-XX-RAFL	-4°F to 125°F	-4°F to 111°F
WTZ8-16L-U-XX-RAFL	-40°F to 122°F	-40°F to 110°F
WTZ8-18L-U-XX-RAFL	-40°F to 145°F	-40°F to 133°F
WTZ8-24L-U-XX-RAFL	-40°F to 122°F	-40°F to 107°F

<sup>1</sup>CT Cold Temp Start Driver (-40°F) Available for (-4°F) standard products



# WTZ

## NARROW LINEAR VAPOR TIGHT

SYSTEMS INFO <sup>1</sup>	3000K		3500K		4000K		5000K		Watts <sup>2</sup>	CRI	Replaces
	Part Numbers	Lumens	Efficacy	Lumens	Efficacy	Lumens	Efficacy	Lumens			
WTZ2-2L-U-XX-RAFL	2,355 lm	125 lm/W	2,431 lm	129 lm/W	2,532 lm	135 lm/W	2,532 lm	135 lm/W	19W	>80	1T8
WTZ2-2L-U-XX-SAFI	2,316 lm	123 lm/W	2,391 lm	127 lm/W	2,490 lm	132 lm/W	2,490 lm	132 lm/W			
WTZ2-2L-U-XX-SACI	2,511 lm	133 lm/W	2,592 lm	138 lm/W	2,700 lm	143 lm/W	2,700 lm	143 lm/W			
WTZ2-2L-U-XX-SPFI	2,143 lm	114 lm/W	2,583 lm	137 lm/W	2,305 lm	122 lm/W	2,305 lm	122 lm/W			
WTZ2-2L-U-XX-SPCI	2,502 lm	133 lm/W	2,583 lm	137 lm/W	2,691 lm	143 lm/W	2,691 lm	143 lm/W			
WTZ2-3L-U-XX-RAFL	3,053 lm	124 lm/W	3,152 lm	128 lm/W	3,283 lm	133 lm/W	3,283 lm	133 lm/W	25W	>80	1T8
WTZ2-3L-U-XX-SAFI	3,003 lm	122 lm/W	3,100 lm	126 lm/W	3,229 lm	131 lm/W	3,229 lm	131 lm/W			
WTZ2-3L-U-XX-SACI	3,256 lm	132 lm/W	3,361 lm	136 lm/W	3,501 lm	142 lm/W	3,501 lm	142 lm/W			
WTZ2-3L-U-XX-SPFI	2,779 lm	113 lm/W	2,869 lm	116 lm/W	2,988 lm	121 lm/W	2,988 lm	121 lm/W			
WTZ2-3L-U-XX-SPCI	3,244 lm	131 lm/W	3,349 lm	136 lm/W	3,489 lm	141 lm/W	3,489 lm	141 lm/W			
WTZ2-4L-U-XX-RAFL	3,877 lm	122 lm/W	4,002 lm	126 lm/W	4,169 lm	132 lm/W	4,169 lm	132 lm/W	32W	>80	2T8
WTZ2-4L-U-XX-SAFI	3,814 lm	120 lm/W	3,937 lm	124 lm/W	4,101 lm	129 lm/W	4,101 lm	129 lm/W			
WTZ2-4L-U-XX-SACI	4,039 lm	131 lm/W	4,268 lm	135 lm/W	4,445 lm	140 lm/W	4,445 lm	140 lm/W			
WTZ2-4L-U-XX-SPFI	3,529 lm	111 lm/W	3,643 lm	115 lm/W	3,795 lm	120 lm/W	3,795 lm	120 lm/W			
WTZ2-4L-U-XX-SPCI	4,025 lm	130 lm/W	4,253 lm	134 lm/W	4,430 lm	140 lm/W	4,430 lm	140 lm/W			
WTZ2-6L-U-XX-RAFL	4,968 lm	124 lm/W	5,128 lm	128 lm/W	5,342 lm	134 lm/W	5,342 lm	134 lm/W	40W	>80	3T8
WTZ2-6L-U-XX-SAFI	4,887 lm	122 lm/W	5,044 lm	126 lm/W	5,254 lm	131 lm/W	5,254 lm	131 lm/W			
WTZ2-6L-U-XX-SACI	5,297 lm	133 lm/W	5,468 lm	137 lm/W	5,696 lm	142 lm/W	5,696 lm	142 lm/W			
WTZ2-6L-U-XX-SPFI	4,522 lm	113 lm/W	4,668 lm	117 lm/W	4,862 lm	122 lm/W	4,862 lm	122 lm/W			
WTZ2-6L-U-XX-SPCI	5,279 lm	132 lm/W	5,449 lm	136 lm/W	5,676 lm	142 lm/W	5,676 lm	142 lm/W			
WTZ4-3L-U-XX-RAFL	2,822 lm	134 lm/W	2,913 lm	138 lm/W	3,034 lm	144 lm/W	3,034 lm	144 lm/W	21W	>80	1T8
WTZ4-3L-U-XX-SAFI	2,775 lm	132 lm/W	2,865 lm	136 lm/W	2,984 lm	142 lm/W	2,984 lm	142 lm/W			
WTZ4-3L-U-XX-SACI	3,009 lm	143 lm/W	3,106 lm	148 lm/W	3,235 lm	154 lm/W	3,235 lm	154 lm/W			
WTZ4-3L-U-XX-SPFI	2,568 lm	122 lm/W	2,651 lm	126 lm/W	2,762 lm	131 lm/W	2,762 lm	131 lm/W			
WTZ4-3L-U-XX-SPCI	2,998 lm	142 lm/W	3,095 lm	147 lm/W	3,224 lm	153 lm/W	3,224 lm	153 lm/W			
WTZ4-4L-U-XX-RAFL	3,789 lm	132 lm/W	3,911 lm	137 lm/W	4,074 lm	142 lm/W	4,074 lm	142 lm/W	29W	>80	2T8
WTZ4-4L-U-XX-SAFI	3,727 lm	130 lm/W	3,847 lm	134 lm/W	4,007 lm	140 lm/W	4,007 lm	140 lm/W			
WTZ4-4L-U-XX-SACI	4,040 lm	141 lm/W	4,170 lm	146 lm/W	4,344 lm	152 lm/W	4,344 lm	152 lm/W			
WTZ4-4L-U-XX-SPFI	3,449 lm	120 lm/W	3,560 lm	124 lm/W	3,708 lm	129 lm/W	3,708 lm	129 lm/W			
WTZ4-4L-U-XX-SPCI	4,026 lm	141 lm/W	4,156 lm	145 lm/W	4,329 lm	151 lm/W	4,329 lm	151 lm/W			
WTZ4-5L-U-XX-RAFL	4,818 lm	127 lm/W	4,993 lm	132 lm/W	5,201 lm	137 lm/W	5,201 lm	137 lm/W	38W	>80	1T5HO
WTZ4-5L-U-XX-SAFI	4,758 lm	125 lm/W	4,911 lm	129 lm/W	5,116 lm	135 lm/W	5,116 lm	135 lm/W			
WTZ4-5L-U-XX-SACI	5,158 lm	136 lm/W	5,324 lm	140 lm/W	5,546 lm	146 lm/W	5,546 lm	146 lm/W			
WTZ4-5L-U-XX-SPFI	4,403 lm	116 lm/W	4,545 lm	120 lm/W	4,734 lm	125 lm/W	4,734 lm	125 lm/W			
WTZ4-5L-U-XX-SPCI	5,140 lm	135 lm/W	5,306 lm	140 lm/W	5,527 lm	146 lm/W	5,527 lm	146 lm/W			
WTZ4-6L-U-XX-RAFL	6,050 lm	128 lm/W	6,245 lm	132 lm/W	6,505 lm	137 lm/W	6,505 lm	137 lm/W	47W	>80	3T8
WTZ4-6L-U-XX-SAFI	5,950 lm	126 lm/W	6,142 lm	130 lm/W	6,398 lm	135 lm/W	6,398 lm	135 lm/W			
WTZ4-6L-U-XX-SACI	6,451 lm	136 lm/W	6,659 lm	141 lm/W	6,936 lm	146 lm/W	6,936 lm	146 lm/W			
WTZ4-6L-U-XX-SPFI	5,506 lm	116 lm/W	5,684 lm	120 lm/W	5,921 lm	125 lm/W	5,921 lm	125 lm/W			
WTZ4-6L-U-XX-SPCI	6,428 lm	136 lm/W	6,636 lm	140 lm/W	6,912 lm	146 lm/W	6,912 lm	146 lm/W			
WTZ4-7L-U-XX-RAFL	7,021 lm	127 lm/W	7,247 lm	131 lm/W	7,549 lm	137 lm/W	7,549 lm	137 lm/W	55W	>80	3T8
WTZ4-7L-U-XX-SAFI	6,905 lm	125 lm/W	7,128 lm	129 lm/W	7,425 lm	134 lm/W	7,425 lm	134 lm/W			
WTZ4-7L-U-XX-SACI	7,486 lm	135 lm/W	7,728 lm	140 lm/W	8,050 lm	146 lm/W	8,050 lm	146 lm/W			
WTZ4-7L-U-XX-SPFI	6,390 lm	116 lm/W	6,596 lm	119 lm/W	6,871 lm	124 lm/W	6,871 lm	124 lm/W			
WTZ4-7L-U-XX-SPCI	7,460 lm	135 lm/W	7,701 lm	139 lm/W	8,022 lm	145 lm/W	8,022 lm	145 lm/W			
WTZ4-8L-U-XX-RAFL	8,061 lm	132 lm/W	8,321 lm	136 lm/W	8,668 lm	142 lm/W	8,668 lm	142 lm/W	61W	>80	2T5HO
WTZ4-8L-U-XX-SAFI	7,929 lm	129 lm/W	8,185 lm	134 lm/W	8,526 lm	139 lm/W	8,526 lm	139 lm/W			
WTZ4-8L-U-XX-SACI	8,596 lm	140 lm/W	8,873 lm	145 lm/W	9,243 lm	151 lm/W	9,243 lm	151 lm/W			
WTZ4-8L-U-XX-SPFI	7,337 lm	120 lm/W	7,574 lm	124 lm/W	7,890 lm	129 lm/W	7,890 lm	129 lm/W			
WTZ4-8L-U-XX-SPCI	8,566 lm	140 lm/W	8,842 lm	144 lm/W	9,211 lm	150 lm/W	9,211 lm	150 lm/W			

<sup>1</sup>LED Chips are frequently updated therefore values are nominal

<sup>2</sup>Please refer to the DLC Qualified Products List at [www.Designlights.org/QPL](http://www.Designlights.org/QPL) to confirm specific product qualifications

<sup>2</sup>Electrical data at 25°C (77°F) 120V. Actual wattage may differ by +/-10%



**WTZ**

**NARROW LINEAR VAPOR TIGHT**

SYSTEMS INFO <sup>1</sup>	3000K		3500K		4000K		5000K		Watts <sup>2</sup>	CRI	Replaces
	Part Numbers	Lumens	Efficacy	Lumens	Efficacy	Lumens	Efficacy	Lumens			
WTZ4-9L-U-XX-RAFL	8,703 lm	133 lm/W	8,984 lm	137 lm/W	9,358 lm	143 lm/W	9,358 lm	143 lm/W	66W	>80	2T5HO
WTZ4-9L-U-XX-SAFL	8,560 lm	131 lm/W	8,836 lm	135 lm/W	9,205 lm	141 lm/W	9,205 lm	141 lm/W			
WTZ4-9L-U-XX-SACL	9,280 lm	142 lm/W	9,579 lm	146 lm/W	9,978 lm	152 lm/W	9,978 lm	152 lm/W			
WTZ4-9L-U-XX-SPFL	7,921 lm	121 lm/W	8,177 lm	125 lm/W	8,518 lm	130 lm/W	8,518 lm	130 lm/W			
WTZ4-9L-U-XX-SPCL	9,248 lm	141 lm/W	9,546 lm	146 lm/W	9,944 lm	152 lm/W	9,944 lm	152 lm/W			
WTZ4-10L-U-XX-RAFL	9,528 lm	131 lm/W	9,835 lm	136 lm/W	10,245 lm	141 lm/W	10,245 lm	141 lm/W	73W	>80	4T8
WTZ4-10L-U-XX-SAFL	9,372 lm	129 lm/W	9,674 lm	133 lm/W	10,077 lm	139 lm/W	10,077 lm	139 lm/W			
WTZ4-10L-U-XX-SACL	10,160 lm	140 lm/W	10,487 lm	145 lm/W	10,924 lm	151 lm/W	10,924 lm	151 lm/W			
WTZ4-10L-U-XX-SPFL	8,672 lm	120 lm/W	8,952 lm	124 lm/W	9,325 lm	129 lm/W	9,325 lm	129 lm/W			
WTZ4-10L-U-XX-SPCL	10,124 lm	140 lm/W	10,451 lm	144 lm/W	10,886 lm	150 lm/W	10,886 lm	150 lm/W			
WTZ4-12L-U-XX-RAFL	12,099 lm	130 lm/W	12,490 lm	134 lm/W	13,010 lm	139 lm/W	13,010 lm	139 lm/W	93W	>80	3T5HO
WTZ4-12L-U-XX-SAFL	11,901 lm	128 lm/W	12,285 lm	132 lm/W	12,797 lm	137 lm/W	12,797 lm	137 lm/W			
WTZ4-12L-U-XX-SACL	12,902 lm	138 lm/W	13,318 lm	143 lm/W	13,873 lm	149 lm/W	13,873 lm	149 lm/W			
WTZ4-12L-U-XX-SPFL	11,013 lm	118 lm/W	11,368 lm	122 lm/W	11,842 lm	127 lm/W	11,842 lm	127 lm/W			
WTZ4-12L-U-XX-SPCL	12,857 lm	138 lm/W	13,271 lm	142 lm/W	13,824 lm	148 lm/W	13,824 lm	148 lm/W			
WTZ8-6L-U-XX-RAFL	6,314 lm	136 lm/W	6,517 lm	140 lm/W	6,789 lm	146 lm/W	6,789 lm	146 lm/W	47W	>80	2T8
WTZ8-6L-U-XX-SAFL	6,210 lm	134 lm/W	6,411 lm	138 lm/W	6,678 lm	144 lm/W	6,678 lm	144 lm/W			
WTZ8-6L-U-XX-SACL	6,732 lm	145 lm/W	6,950 lm	150 lm/W	7,239 lm	156 lm/W	7,239 lm	156 lm/W			
WTZ8-6L-U-XX-SPFL	5,747 lm	124 lm/W	5,932 lm	128 lm/W	6,179 lm	133 lm/W	6,179 lm	133 lm/W			
WTZ8-6L-U-XX-SPCL	6,709 lm	144 lm/W	6,925 lm	149 lm/W	7,214 lm	155 lm/W	7,214 lm	155 lm/W			
WTZ8-8L-U-XX-RAFL	8,307 lm	132 lm/W	8,575 lm	137 lm/W	8,932 lm	142 lm/W	8,932 lm	142 lm/W	63W	>80	2T8
WTZ8-8L-U-XX-SAFL	8,171 lm	130 lm/W	8,434 lm	134 lm/W	8,786 lm	140 lm/W	8,786 lm	140 lm/W			
WTZ8-8L-U-XX-SACL	8,858 lm	141 lm/W	9,143 lm	146 lm/W	9,524 lm	152 lm/W	9,524 lm	152 lm/W			
WTZ8-8L-U-XX-SPFL	7,561 lm	120 lm/W	7,805 lm	124 lm/W	8,130 lm	130 lm/W	8,130 lm	130 lm/W			
WTZ8-8L-U-XX-SPCL	8,827 lm	141 lm/W	9,112 lm	145 lm/W	9,491 lm	151 lm/W	9,491 lm	151 lm/W			
WTZ8-10L-U-XX-RAFL	9,802 lm	129 lm/W	10,118 lm	133 lm/W	10,540 lm	138 lm/W	10,540 lm	138 lm/W	76W	>80	3T5HO
WTZ8-10L-U-XX-SAFL	9,641 lm	127 lm/W	9,952 lm	131 lm/W	10,367 lm	136 lm/W	10,367 lm	136 lm/W			
WTZ8-10L-U-XX-SACL	10,452 lm	137 lm/W	10,789 lm	142 lm/W	11,239 lm	147 lm/W	11,239 lm	147 lm/W			
WTZ8-10L-U-XX-SPFL	8,922 lm	117 lm/W	9,210 lm	121 lm/W	9,594 lm	126 lm/W	9,594 lm	126 lm/W			
WTZ8-10L-U-XX-SPCL	10,416 lm	137 lm/W	10,752 lm	141 lm/W	11,200 lm	147 lm/W	11,200 lm	147 lm/W			
WTZ8-12L-U-XX-RAFL	10,968 lm	135 lm/W	11,321 lm	139 lm/W	11,793 lm	145 lm/W	11,793 lm	145 lm/W	81W	>80	6T8
WTZ8-12L-U-XX-SAFL	10,788 lm	133 lm/W	11,136 lm	137 lm/W	11,600 lm	143 lm/W	11,600 lm	143 lm/W			
WTZ8-12L-U-XX-SACL	11,695 lm	144 lm/W	12,072 lm	148 lm/W	12,575 lm	155 lm/W	12,575 lm	155 lm/W			
WTZ8-12L-U-XX-SPFL	9,983 lm	123 lm/W	10,305 lm	127 lm/W	10,734 lm	132 lm/W	10,734 lm	132 lm/W			
WTZ8-12L-U-XX-SPCL	11,654 lm	143 lm/W	12,030 lm	148 lm/W	12,531 lm	154 lm/W	12,531 lm	154 lm/W			
WTZ8-14L-U-XX-RAFL	13,468 lm	130 lm/W	13,903 lm	134 lm/W	14,482 lm	140 lm/W	14,482 lm	140 lm/W	103W	>80	6T8
WTZ8-14L-U-XX-SAFL	13,247 lm	128 lm/W	13,675 lm	132 lm/W	14,245 lm	138 lm/W	14,245 lm	138 lm/W			
WTZ8-14L-U-XX-SACL	14,361 lm	139 lm/W	14,825 lm	143 lm/W	15,442 lm	149 lm/W	15,442 lm	149 lm/W			
WTZ8-14L-U-XX-SPFL	12,259 lm	119 lm/W	12,654 lm	122 lm/W	13,182 lm	127 lm/W	13,182 lm	127 lm/W			
WTZ8-14L-U-XX-SPCL	14,311 lm	138 lm/W	14,773 lm	143 lm/W	15,389 lm	149 lm/W	15,389 lm	149 lm/W			
WTZ8-16L-U-XX-RAFL	15,218 lm	130 lm/W	15,709 lm	134 lm/W	16,363 lm	139 lm/W	16,363 lm	139 lm/W	117W	>80	4T5HO
WTZ8-16L-U-XX-SAFL	14,968 lm	127 lm/W	15,451 lm	132 lm/W	16,095 lm	137 lm/W	16,095 lm	137 lm/W			
WTZ8-16L-U-XX-SACL	16,227 lm	138 lm/W	16,750 lm	143 lm/W	17,448 lm	149 lm/W	17,448 lm	149 lm/W			
WTZ8-16L-U-XX-SPFL	13,851 lm	118 lm/W	14,298 lm	122 lm/W	14,894 lm	127 lm/W	14,894 lm	127 lm/W			
WTZ8-16L-U-XX-SPCL	16,170 lm	138 lm/W	16,692 lm	142 lm/W	17,387 lm	148 lm/W	17,387 lm	148 lm/W			
WTZ8-18L-U-XX-RAFL	16,614 lm	136 lm/W	17,149 lm	140 lm/W	17,864 lm	146 lm/W	17,864 lm	146 lm/W	122W	>80	6T5HO
WTZ8-18L-U-XX-SAFL	16,341 lm	133 lm/W	16,868 lm	138 lm/W	17,571 lm	144 lm/W	17,571 lm	144 lm/W			
WTZ8-18L-U-XX-SACL	17,715 lm	145 lm/W	18,286 lm	150 lm/W	19,048 lm	156 lm/W	19,048 lm	156 lm/W			
WTZ8-18L-U-XX-SPFL	15,122 lm	124 lm/W	15,609 lm	128 lm/W	16,260 lm	133 lm/W	16,260 lm	133 lm/W			
WTZ8-18L-U-XX-SPCL	17,654 lm	144 lm/W	18,223 lm	149 lm/W	18,982 lm	155 lm/W	18,982 lm	155 lm/W			
WTZ8-24L-U-XX-RAFL	21,936 lm	136 lm/W	22,644 lm	140 lm/W	23,587 lm	146 lm/W	23,587 lm	146 lm/W	162W	>80	6T5HO
WTZ8-24L-U-XX-SAFL	21,576 lm	133 lm/W	22,272 lm	138 lm/W	23,200 lm	144 lm/W	23,200 lm	144 lm/W			
WTZ8-24L-U-XX-SACL	23,390 lm	145 lm/W	24,145 lm	149 lm/W	25,151 lm	156 lm/W	25,151 lm	156 lm/W			
WTZ8-24L-U-XX-SPFL	19,966 lm	124 lm/W	20,610 lm	128 lm/W	21,469 lm	133 lm/W	21,469 lm	133 lm/W			
WTZ8-24L-U-XX-SPCL	23,309 lm	144 lm/W	24,061 lm	149 lm/W	25,064 lm	155 lm/W	25,064 lm	155 lm/W			

<sup>1</sup>LED Chips are frequently updated therefore values are nominal

<sup>2</sup>Please refer to the DLC Qualified Products List at [www.Designlights.org/QPL](http://www.Designlights.org/QPL) to confirm specific product qualifications

<sup>2</sup>Electrical data at 25°C (77°F) 120V. Actual wattage may differ by +/-10%



# WTZ NARROW LINEAR VAPOR TIGHT

## CONTROLS OPTIONS

### BASIC

#### WLOS

Standard on/off wet location rated PIR occupancy sensor. Comes with 360 degree lens. Sensor mounted off end of fixture.

#### WLOSPC

Standard on/off wet location rated PIR occupancy sensor with photocell control. When installed, fixture will not activate unless 1. motion is detected and 2. light levels are below the preset level. When activated, fixture will turn on to 100% light output and will only shut off when one of the two levels listed above are met. If no motion is detected and light levels fall below preset level the fixture remains off. Sensor mounted off end of fixture.

#### USBD

User Selectable Bi-Level Dimming wet location rated PIR occupancy sensor. Allows the end user to manually select the unoccupied dimming level. Once motion is detected, the fixture will return to 100% light output. Sensor mounted off end of fixture.

#### BDxx

Factory set Bi-Level Dimming wet location rated PIR occupancy sensor. Sensor is set to dim level, as indicated in the "xx" portion of the part number, when the area is unoccupied. Example: BD20 sets the fixture to dim down to 20% lumen output when the area is unoccupied. Once motion is detected, the fixture will return to 100% light output. Sensor mounted off end of fixture.

#### BDxxPC

Factory set Bi-Level Dimming with motion and photocell. Sensor is set to dim level, as indicated in the "xx" portion of the part number, when the area is unoccupied and will not return to 100% light output unless 1. motion is detected and 2. the light level is below the preset level. Example: BD20PC sets the fixture to dim down to 20% lumen output when the area is unoccupied and will not return to 100% light output unless the above conditions are met for both motion and light level readings. Sensor mounted off end cap of fixture.

#### MWS

Standard on/off wet location rated microwave occupancy sensor. Sensor installed on LED gear tray behind lens.

#### MWUSBD

User Selectable Bi-Level Dimming wet location rated microwave occupancy sensor. Allows the end user to manually select the unoccupied dimming level. Once motion is detected, the fixture will return to 100% light output. Requires use of MW/RC programming tool; one needed per project. Sensor installed on LED gear tray behind lens.

## CONTROLS OPTIONS

### ADVANCED

#### NUROAir by ILLUMUS

##### NURO

NUROAir Plug n Play Bluetooth Sensor is the optimal groupable controls lighting solution. With main features such as Plug and Play, PIR Motion Sensing, Occupancy/Vacancy and Daylight Harvesting (WHT) - this flexibility makes the NUROAir Plug n Play Sensor ideal for tailoring lighting to specific space needs, optimizing both ambiance and efficiency. The NUROAir App, available for download on iOS and Google Play Store, offers a user-friendly interface for automatic or manual customization of your space. Through the app, users can configure sensor settings such as the Light Output, CCT, Hold Time, Standby Time/Level, High/Low End Trim, Background Light Level, Set Schedules, and Control Lighting Groups or Zones, all from a mobile or tablet device. Manual control is also available with a range of compatible wireless & wired wall switch options. Microwave sensor option available with NURO/MWS selection.



Click Here or Scan Code  
to Learn More About

NUROAir Bluetooth Controls

### EASYSense

#### Philips ESMC/HB

EasySense sensor combines occupancy sensing, daylight harvesting and institutional tuning in one compact solution. This is an ideal control for any high bay application. Each device allows you to turn on/off occupancy and/or daylight harvesting functions as well as set the full light output, background light level, occupancy prolong time, occupancy grace fading time & occupancy time out/hold time. Easily Controlled via Mobile Phone with Philips MasterConnect Bluetooth App. (Sold separately). Sensor mounted off end cap of fixture.



### Default Factory Settings

Occupancy based control	Enabled
Daylight based control	Enabled
Occupancy Mode	Auto-on/off
Group/Zone Occupancy Sharing	Enabled
Zone Occupancy Sharing	Disabled
Group/Zone Lighting Behavior	Background level
Field Task Tuning	100%
Eco-On Level	100%
Background Light Level	20%
Hold Time	10 minutes
Prolong Time	10 minutes
Grace Fading	10 seconds
Fade to Switch-On	1 second (fixed value)
Fade to Switch-Off	1 second (fixed value)

### Occupancy Sensing Based on 52ft mounting height

Top coverage

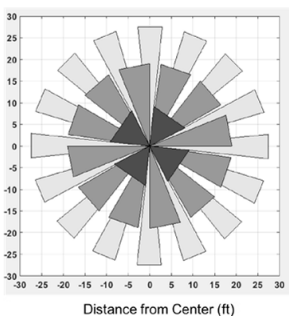

Side coverage

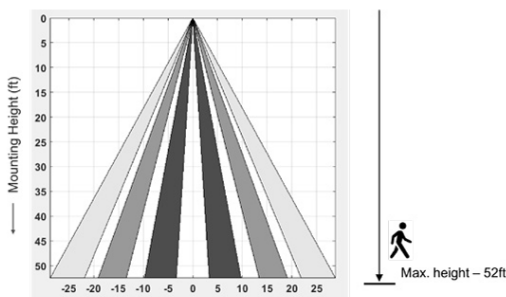



**WTZ**

# NARROW LINEAR VAPOR TIGHT

## CONTROLS OPTIONS

### ADVANCED

#### DROP NIPPLE SENSOR

##### FSP311B/Lx

FSP-311 offers fully adjustable high and low dimmed light levels with optional photocell. Hold off setpoint with automatic calibration option. Adjustable time delay and cut off delay. Sensor adjustable programming via iOS® or Android® 'Sensor Configuration' App. Sensor mounted on center driver channel.

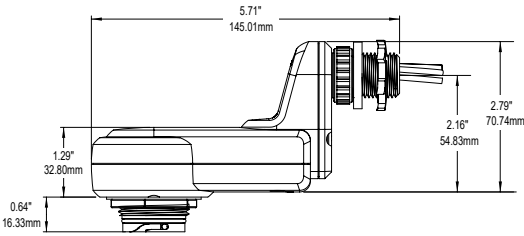

#### FACTORY DEFAULTS

High Mode.....	10 V
Low Mode .....	1 V
Time Delay.....	5 min
Cut Off.....	1 hr
Sensitivity .....	High
Hold Off .....	Disabled
Ramp Up.....	Disabled
Fade Down.....	Disabled
Photocell Setpoint for On/Off.....	Disabled
Continuous Dimming.....	Disabled



#### FSP-311/L3

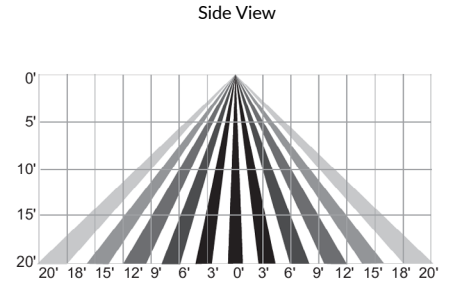
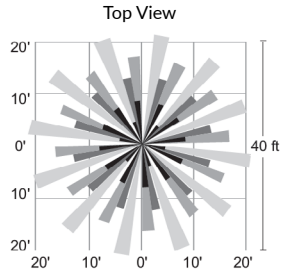

#### FSP-311/L7

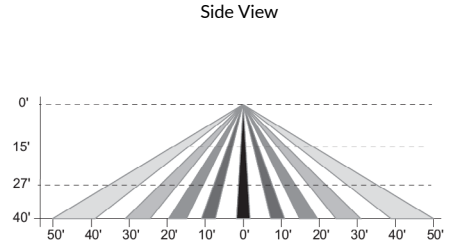
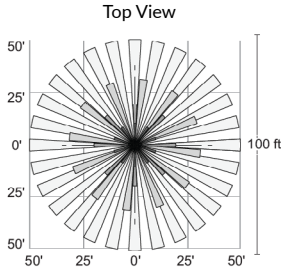



**WTZ**

**NARROW LINEAR VAPOR TIGHT**

**MOUNTING OPTIONS**

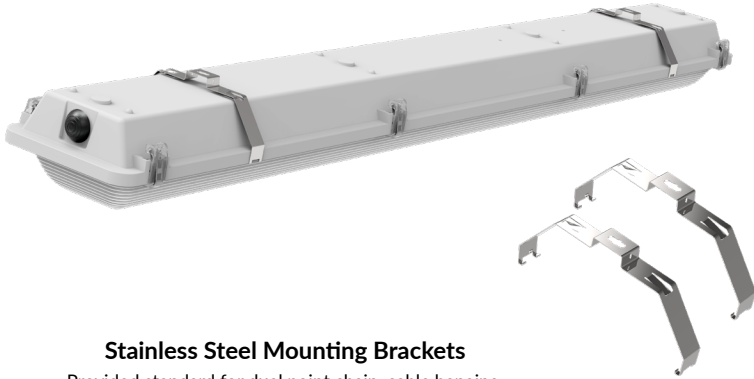

**Stainless Steel Mounting Brackets**

Provided standard for dual point chain, cable hanging, and surface mount.

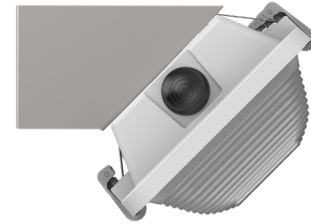

**AB45DEG/SS**

(x = 6' or 10') 45° Stainless Steel Angled Wall Mount Bracket. Two standard per set. One set required per fixture.



**+WTZ-ACxL-KIT**

Adjustable loop aircraft cable set (x = 6' or 10')

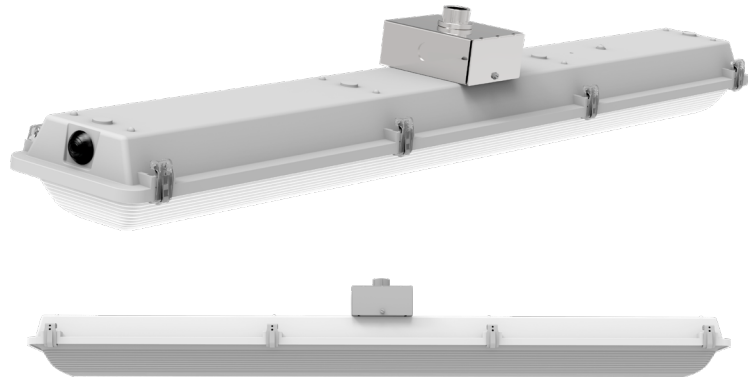

**FMB/HUB34 or FMB/HUB12**

Fixture Mounting Box utilized when pendant mounting. One needed per 4ft section.



# WTZ NARROW LINEAR VAPOR TIGHT

## LINE DRAWINGS

### WTZ2

Top View

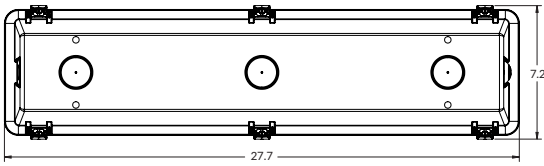

End View

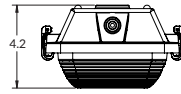

LENS TYPE:  
RAFL

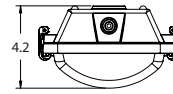

LENS TYPE:  
SAFL  
SACL  
SPFL  
SPCL

Side View

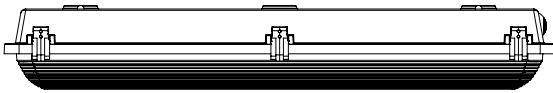

### WTZ4

Top View

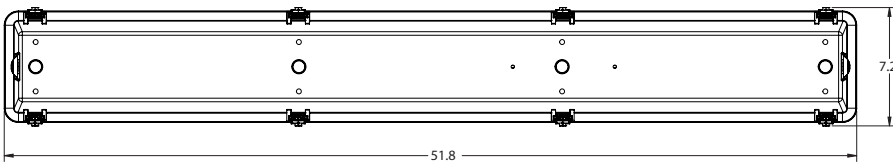

End View

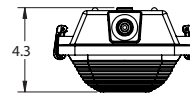

LENS TYPE:  
RAFL

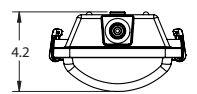

LENS TYPE:  
SAFL  
SACL  
SPFL  
SPCL

Side View



### WTZ8

Top View

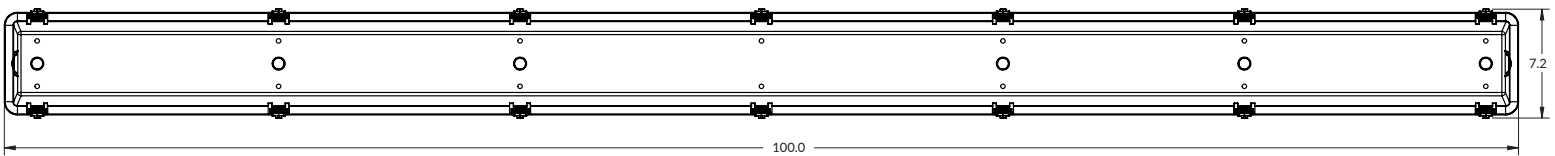

Side View

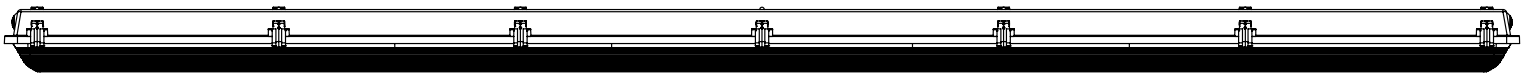

End View

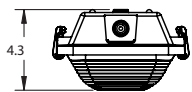

LENS TYPE:  
RAFL

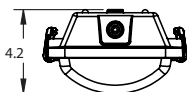

LENS TYPE:  
SAFL  
SACL  
SPFL  
SPCL

**WTZ****NARROW LINEAR VAPOR TIGHT****PHOTOMETRIC DATA**

LUMINAIRE DATA	
Part Number	WTZ2-4L-U-50-RAFL
Description	2ft Amazon Vapor Tight, 4,000 Lumens, Ribbed Frosted Acrylic Lens
Fixture Lumens (lm)	4,172 lm
Wattage (W)	80 W
Efficacy (lm/W)	164 lm/W
Mounting	Suspended
Spacing Criteria	0° = 1.30, 90° = 1.29

ZONAL LUMEN SUMMARY		
Zone	Lumens (lm)	% Fixture
0° - 40°	1,744	42%
0° - 60°	3,043	73%
0° - 90°	4,010	96%
90° - 180°	162	4%
0° - 180°	4,172	100%

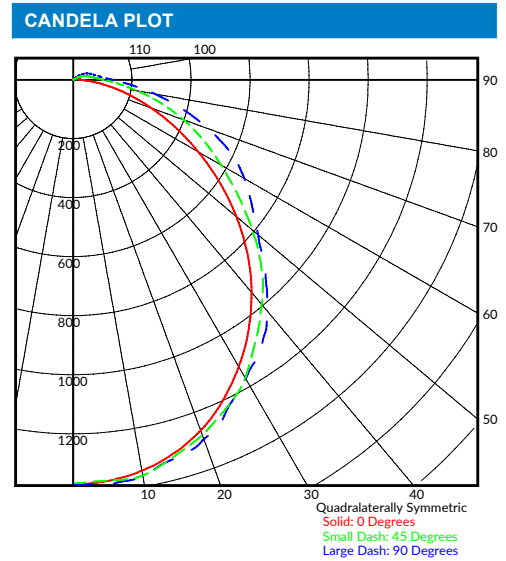

LUMINAIRE DATA	
Part Number	WTZ4-8L-U-50-RAFL
Description	4ft Amazon Vapor Tight, 8,000 Lumens, Ribbed Frosted Acrylic Lens
Fixture Lumens (lm)	8,673 lm
Wattage (W)	80 W
Efficacy (lm/W)	152 lm/W
Mounting	Suspended
Spacing Criteria	0° = 1.29, 90° = 0.77

ZONAL LUMEN SUMMARY		
Zone	Lumens (lm)	% Fixture
0° - 40°	3,626	42%
0° - 60°	6,327	73%
0° - 90°	8,338	96%
90° - 180°	336	4%
0° - 180°	8,673	100%

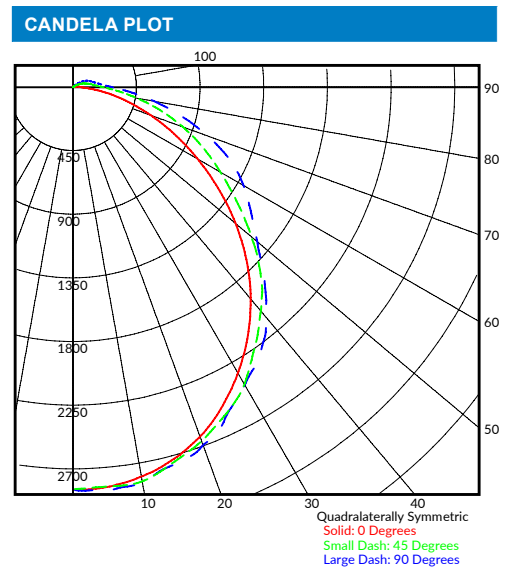

LUMINAIRE DATA	
Part Number	WTZ8-16L-U-50-RAFL
Description	8ft Amazon Vapor Tight, 16,000 Lumens, Ribbed Frosted Acrylic Lens
Fixture Lumens (lm)	16,371 lm
Wattage (W)	80 W
Efficacy (lm/W)	159 lm/W
Mounting	Suspended
Spacing Criteria	0° = 1.26, 90° = 1.26

ZONAL LUMEN SUMMARY		
Zone	Lumens (lm)	% Fixture
0° - 40°	6,845	42%
0° - 60°	11,944	73%
0° - 90°	15,737	96%
90° - 180°	634	4%
0° - 180°	16,371	100%

