

LED Retrofit – Installation Instructions

For linear fluorescent strip fixtures



WARNING – RISK OF FIRE OR ELECTRIC SHOCK. LUMINAIRE WIRING AND ELECTRICAL PARTS MAY BE DAMAGED WHEN DRILLING FOR INSTALLATION OF LED RETROFIT KIT. CHECK FOR ENCLOSED WIRING AND COMPONENTS

AVERTISSEMENT - RISQUE D'INCENDIE OU DE CHOC ÉLECTRIQUE. CÂBLAGE DU LUMINAIRE ET PIÈCES ÉLECTRIQUES PEUVENT ÊTRE ENDOMMAGÉS LORS DU PERÇAGE POUR L'INSTALLATION DU KIT DE CONVERSION À DEL. VÉRIFIER LE CÂBLAGE ET LES COMPOSANTS CLOS



WARNING – RISK OF FIRE OR ELECTRIC SHOCK. LED RETROFIT KIT INSTALLATION REQUIRES KNOWLEDGE OF LUMINAIRES ELECTRICAL SYSTEMS. IF NOT QUALIFIED, DO NOT ATTEMPT INSTALLATION. CONTACT A QUALIFIED ELECTRICIAN.

ATTENTION - RISQUE DE FEU OU DE CHOC ÉLECTRIQUE. L'INSTALLATION DU KIT DE RÉNOVATION LED NÉCESSITE DES CONNAISSANCES SUR LES SYSTÈMES ÉLECTRIQUES DES LUMINAIRES. SI VOUS N'ÊTES PAS QUALIFIÉS, N'ESSEYER PAS DE L'INSTALLER. CONTACTER UN ÉLECTRICIEN QUALIFIÉ.



WARNING – RISK OF FIRE OR ELECTRIC SHOCK. INSTALL THIS KIT ONLY IN LUMINAIRES THAT HAVE THE CONSTRUCTION FEATURES AND DIMENSIONS SHOWN IN THE PHOTOGRAPHS AND/OR DRAWINGS AND WHERE THE INPUT RATING OF THE RETROFIT KIT DOES NOT EXCEED THE INPUT RATING OF THE LUMINAIRE.

ATTENTION - RISQUE DE FEU OU DE CHOC ÉLECTRIQUE. INSTALLER CE KIT UNIQUEMENT DANS LES LUMINAIRES DONT LES CARACTÉRISTIQUES ET LES DIMENSIONS CORRESPONDENT À CELLES INDIQUÉES DANS LES PHOTOS ET SCHÉMAS



WARNING – TO PREVENT WIRING DAMAGE OR ABRASION, DO NOT EXPOSE WIRING TO EDGES OF SHEET METAL OR OTHER SHARP OBJECTS.

ATTENTION - AFIN D'ÉVITER TOUTE ABRASION OU DOMMAGE DU CÂBLAGE ÉLECTRIQUE, NE PAS L'EXPOSER AUX ARRÊTES DES FEUILLES MÉTALLIQUES OU TOUT AUTRE OBJET TRANCHANT



THE RETROFIT KIT IS ACCEPTED AS A COMPONENT OF A LUMINAIRE WHERE THE SUITABILITY OF THE COMBINATION SHALL BE DETERMINED BY CSA OR AUTHORITIES HAVING JURISDICTION



THIS RETROFIT KIT IS SUITABLE FOR LUMINAIRES IN DRY OR DAMP LOCATIONS ONLY



ONLY THOSE HOLES INDICATED IN THE PHOTOGRAPHS AND/OR DRAWINGS MAY BE ALTERED AS A RESULT OF KIT INSTALLATION. DO NOT LEAVE ANY OTHER OPEN HOLES IN AN ENCLOSURE OF WIRING OR ELECTRICAL COMPONENTS.



DO NOT MAKE OR ALTER ANY OPEN HOLES IN AN ENCLOSURE OF WIRING OR ELECTRICAL COMPONENTS DURING KIT INSTALLATION.

Parts included in this kit:

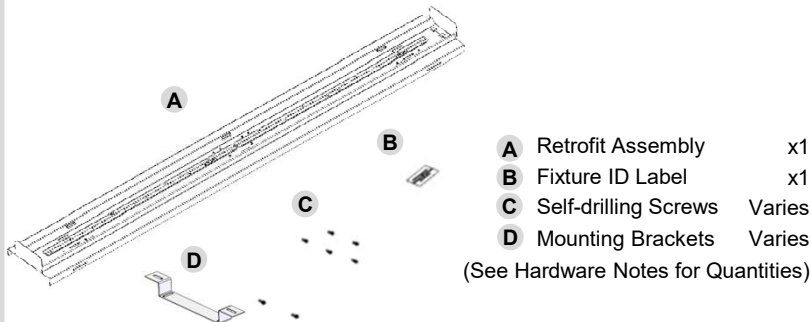

Tools required:



Luminaire compatibility:

Install this retrofit kit only in fluorescent fixtures with features similar to those pictured here.



Dimensions and number of lamps may vary.

Installer Notes:

A set of labels with model, serial number, and date of manufacture are included with the kit and must be adhered within the original luminaire during installation.

Examine all parts that are not intended to be replaced by the retrofit kit for damage and replace any damaged parts prior to installation of the retrofit kit.

It is recommended that a single test unit is installed before full renovation to ensure fixture compatibility.

Hardware Notes:

	Tek Screws		Brackets	
Tek Screw Count	4 FT	8 FT	4 FT	8 FT
Fixed Width Strip	4	6	0	0
Adjustable Strip	8	12	2	3
Surface	8	12	2	3
Lowbay	8	12	2	3

Instructions:

1 Read all Warnings and Installer Notes before proceeding with this retrofit.

2 Check to ensure all parts listed are included in your retrofit kit.

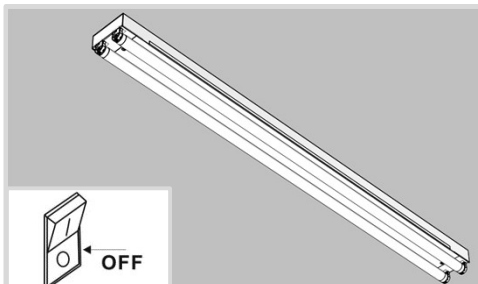

3 Shut off or disconnect power to the fixture.

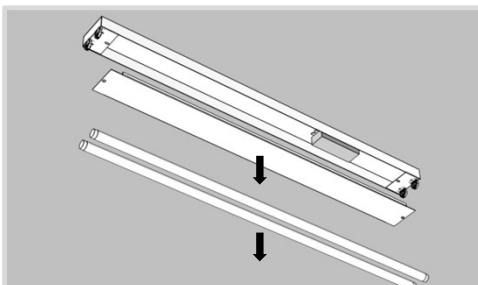

4 Remove fluorescent lamps and ballast cover. Dispose of the lamps in proper accordance with current state and federal regulation. Fluorescent lamps contain hazardous materials.

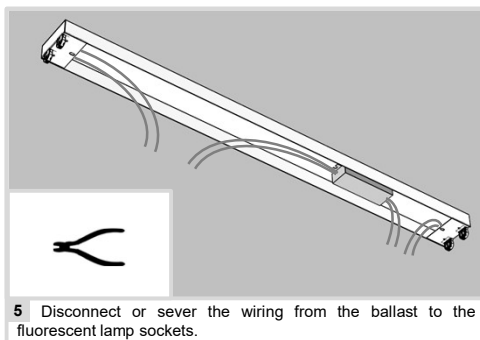

5 Disconnect or sever the wiring from the ballast to the fluorescent lamp sockets.

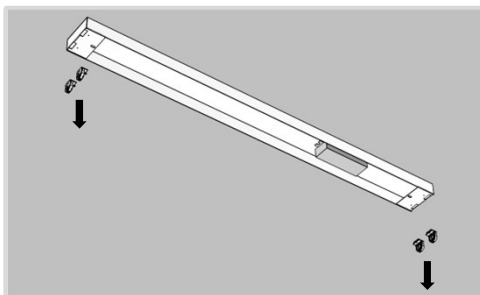

6 Remove the fluorescent lamp sockets and any wiring that may still be attached.

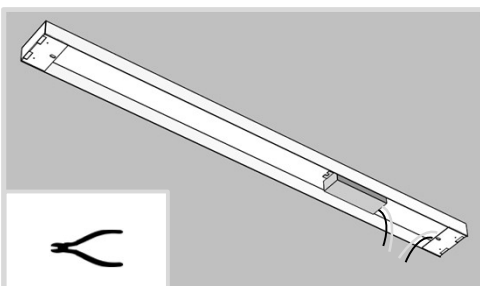

7 Disconnect or sever the wiring from the AC power input to the fluorescent ballast. If space is limited, remove the ballast.

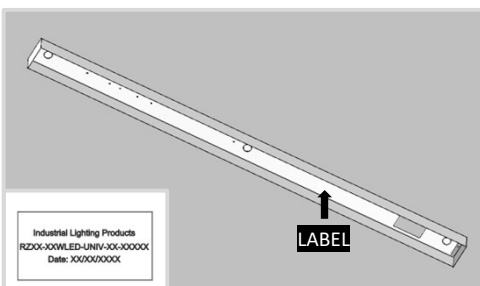

8 Adhere the Fixture ID Label to the original fixture housing in a clearly visible location. This label is required by UL standards.

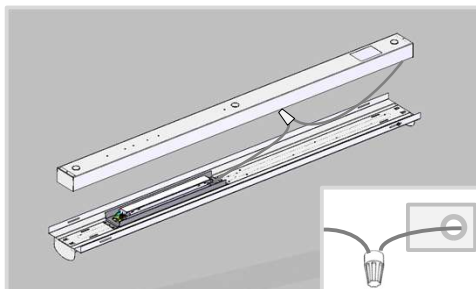

9 Ground the fixture using the ground cable (green) with proper connectors in accordance with current codes and regulations.

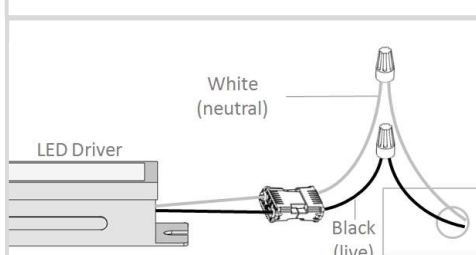

10 Connect AC input cables to the incoming AC power connection using the proper connectors in accordance with current state and federal regulation.

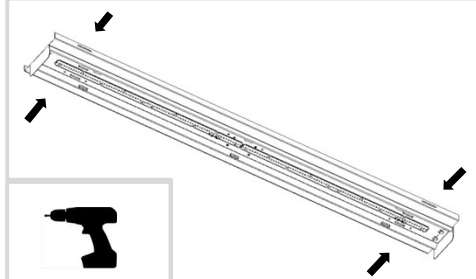

11a (FIXED WIDTH STRIP MOUNT) Fit the LED Channel around the existing fixture and attach it using at least four (4) of the provided self-drilling Screws. There should not be any gaps between the LED gear tray assembly and the original fixture housing.

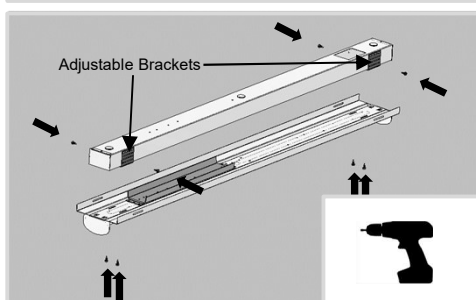

11b (ADJUSTABLE STRIP MOUNT) Fit the adjustable brackets as shown and bend them to wrap around the housing. Secure the brackets to the housing with four (4) self-drilling screws. Then fit the LED gear tray assembly to the brackets using at least four (4) of the provided Self-Drilling Screws.

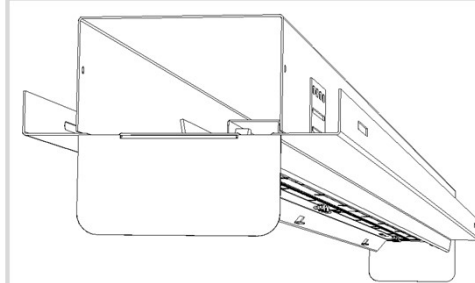

11b (ADJUSTABLE STRIP MOUNT) Be aware that after installation LED tray will be hanging on the sides

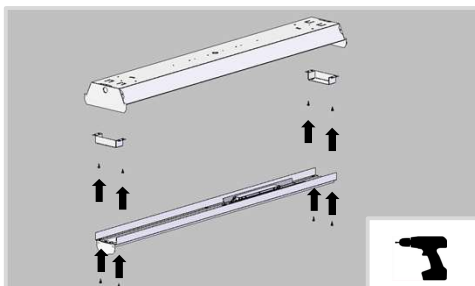

11c (SURFACE MOUNT) Install brackets to the housing as shown using four (4) self-drilling screws. Then fit the LED gear tray assembly to the brackets using at least four (4) more of the provided self-Drilling Screws.

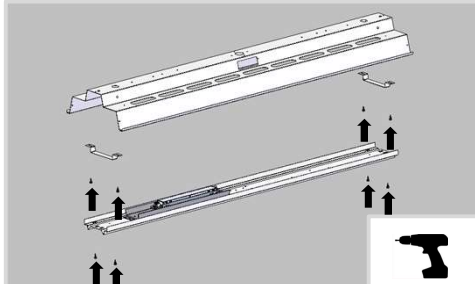

11d (LOWBAY MOUNT) Install brackets to the housing as shown using four (4) self-drilling screws. Then fit the LED gear tray assembly to the brackets to using four (4) more of the provided self-drilling screws.

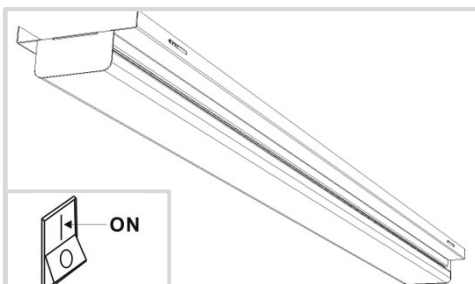

12 Turn on or reconnect power to the fixture to complete the installation.

Housing Dimension Requirements:

This retrofit kit is designed to fit housings that meet the following dimension requirements, depending on mounting type:

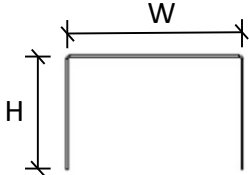

FIXED WIDTH STRIP MOUNT
Width (W) of housing should match the width of Fixed Width Strip Retrofit.
Height (H) of housing should be no less than 1.75".

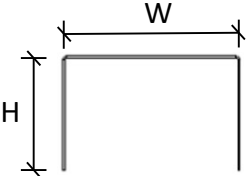

ADJUSTABLE STRIP MOUNT
Width (W) of housing should be between 2.8" and 5.5".
Height (H) of housing should be no less than 1.75".

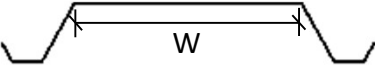

SURFACE MOUNT
Width (W) of housing should be no less than 5.6".

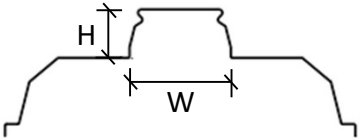

LOWBAY MOUNT
Width (W) of housing should be no less than 2.8".
Height (H) of housing should be no less than 1.75".