



LED CANOPY INSTALLATION INSTRUCTIONS

CAUTION

THE LED CANOPY LIGHT MUST BE INSTALLED IN ACCORDANCE WITH ALL APPLICABLE ELECTRICAL CODES BY PERSONS FAMILIAR WITH THE INSTALLATION, OPERATION, AND/OR MAINTENANCE OF THE PRODUCTS AND THE HAZARDS INVOLVED. THE LED CANOPY LIGHT MUST BE INSTALLED WITH UL LISTED LIQUID-TIGHT CONDUIT FITTINGS.

WARNING

1. Risk of fire or electric shock.
2. Verify that supply voltage is correct comparing it with the luminaire label information.
3. Make sure the accessories and wires are complete and intact during the installation.
4. Installation requires knowledge of electrical systems. For install by qualified electrician only. Do not attempt installation if not qualified.
5. This fixture should only be installed in place of existing luminaries that have the construction features and dimensions specified in this manual.
6. Do not expose any wire to edge of sheet metal and/or other sharp objects that may cause damage or abrasion.
7. Do not change existing open holes or create any additional holes in the fixture or its components during installation.

WARNING

1. Turn OFF electrical power at fuse or circuit breaker box before and during installation and maintenance.
2. Do not use the LED Canopy Light near heating appliances/elements.
3. The input voltage and lamps should be matched after connecting the power line, please make sure the wiring section is insulated.
4. Suitable for WET Locations.
5. Operated within an ambient temperature range of -30°C(-22°F) and 40°C(104°F).
6. Not intended for use with emergency exits.

General Wiring Diagram:

Fixture Wiring Diagram

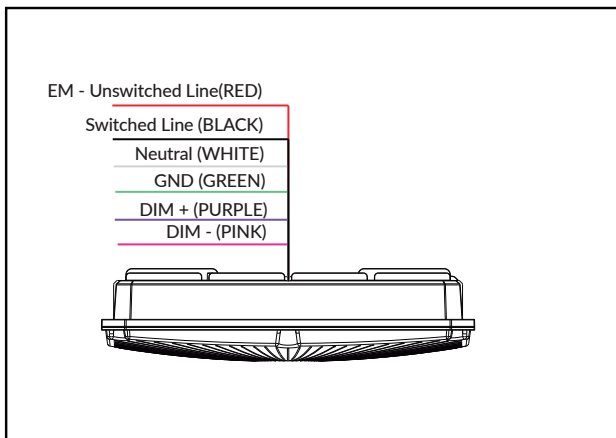

Driver Wiring Diagram

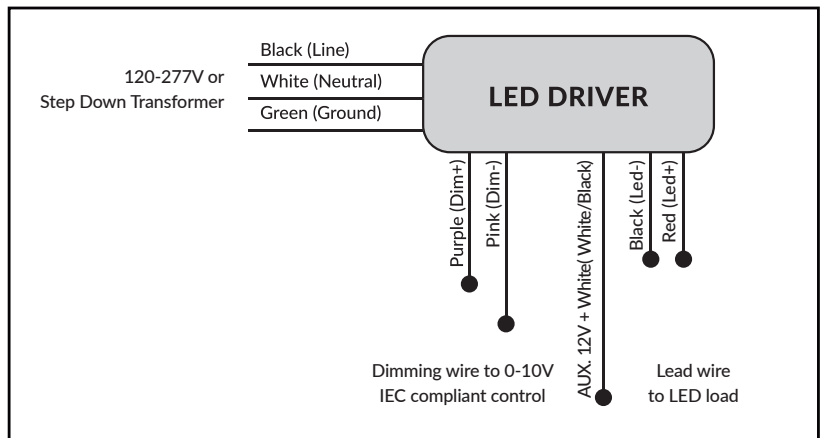

Installation Steps

TURN OFF POWER FROM MAIN CIRCUIT BREAKER

CCT & POWER SETTINGS

- Unscrew the NPT plug in the center using a screwdriver (Figure 1).
- Adjust the CCT and Wattage switch to the desired color temperature and wattage through the thread hole (Figure 2).
- Use a screwdriver to securely tighten the NPT plug in the center (Figure 3).
- Factory setting: Max wattage & 5000K

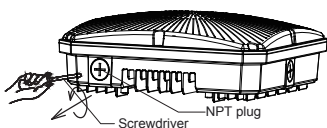

Figure 1

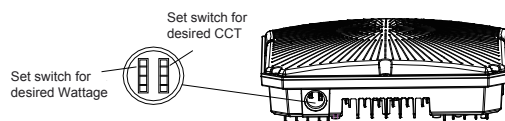

Figure 2

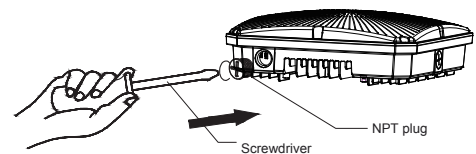

Figure 3



Installation Steps

SURFACE MOUNTED INSTALLATION

- Unfasten the plate's screw to detach the mounting plate from the fixture (Figure 1).
- Use provided hardware (4 mounting screws) to fix mounting plate to embedded J-box (not provided) (Figure 2).
- Hang the fixture to mounting plate using mounting plate latch and fixture hook, and make appropriate electrical connections (Figure 3).
- Lift and Hook-up fixture on the mounting plate (Figure 4).
- Secure the fixture to the mounting plate by fastening back the plate's screw and installation is complete (Figure 5).

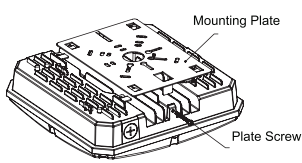

Figure 1

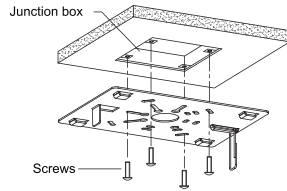

Figure 2

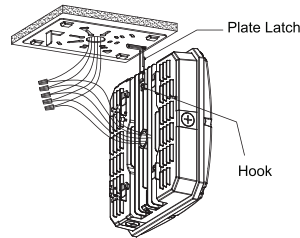

Figure 3

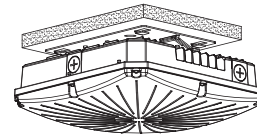

Figure 4

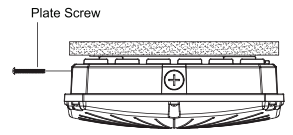

Figure 5

PENDANT MOUNTED INSTALLATION

- Make appropriate electrical connection between fixture and power supply wires from 3/4" NPT pipe (not provided) (Figure 1).
- Screw-in the threaded end of the NPT pipe to the canopy fixture's thread, ensure that the installation is secure and installation is complete (Figure 2).

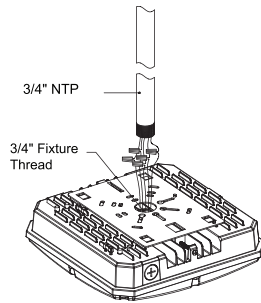

Figure 1

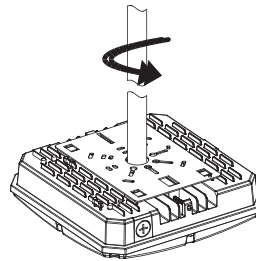

Figure 2

Part No.	Input Wattage	Working Current	Voltage	PF	Dimming
VCS-3L/5L/7L-U-CCTS-X-XXX	28-40-60W	Max.0.55A	120-277V, 50/60Hz	>0.9	0-10V
VCS-3L-U-30-X-XXX	28W	Max.0.55A			
VCS-3L-U-40-X-XXX					
VCS-3L-U-50-X-XXX					
VCS-5L-U-30-X-XXX	40W	Max.0.55A			
VCS-5L-U-40-X-XXX					
VCS-5L-U-50-X-XXX					
VCS-7L-U-30-X-XXX	60W	Max.0.55A			
VCS-7L-U-40-X-XXX					
VCS-7L-U-50-X-XXX					
VCM-9L/11L/14L-U-CCTS-X-XXX	70-90-110W	Max. 1.01A	120-277V, 50/60Hz	>0.9	0-10V
VCM-9L-U-30-X-XXX	70W	Max. 1.01A			
VCM-9L-U-40-X-XXX					
VCM-9L-U-50-X-XXX					
VCM-11L-U-30-X-XXX	90W	Max. 1.01A			
VCM-11L-U-40-X-XXX					
VCM-11L-U-50-X-XXX					
VCM-14L-U-30-X-XXX	110W	Max. 1.01A			
VCM-14L-U-40-X-XXX					
VCM-14L-U-50-X-XXX					

*X can be "M" or "W" for light distribution. *XXX can be any finish.